

0 603 230 001

Stand } 08-04-15
Issue } 08-04-16

Fig./Abb. 1

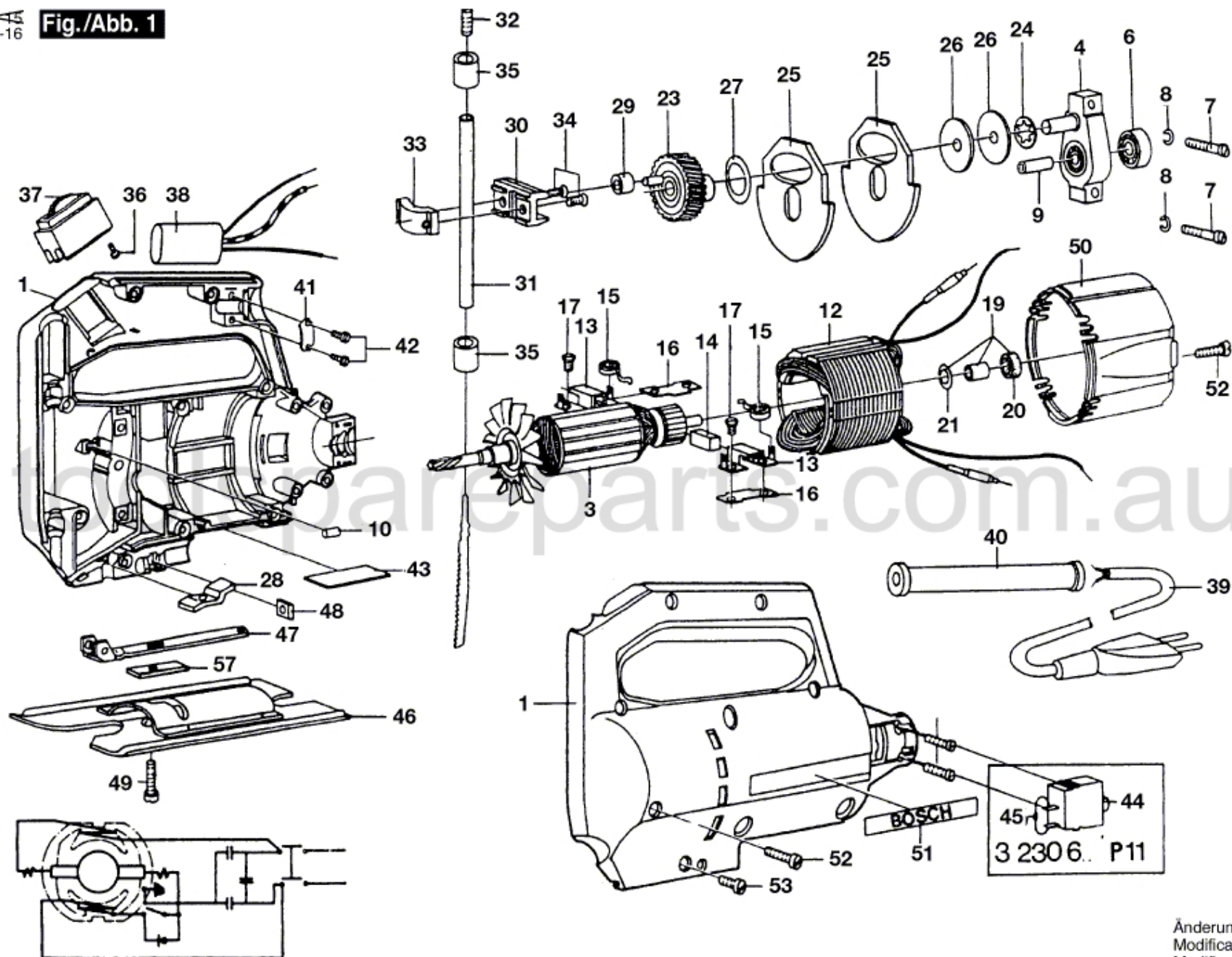

Änderungen vorbehalten
Modifications reserved
Modifications reserves
Salvo modificaciones